

TEPELNÉ ŽIARENIE

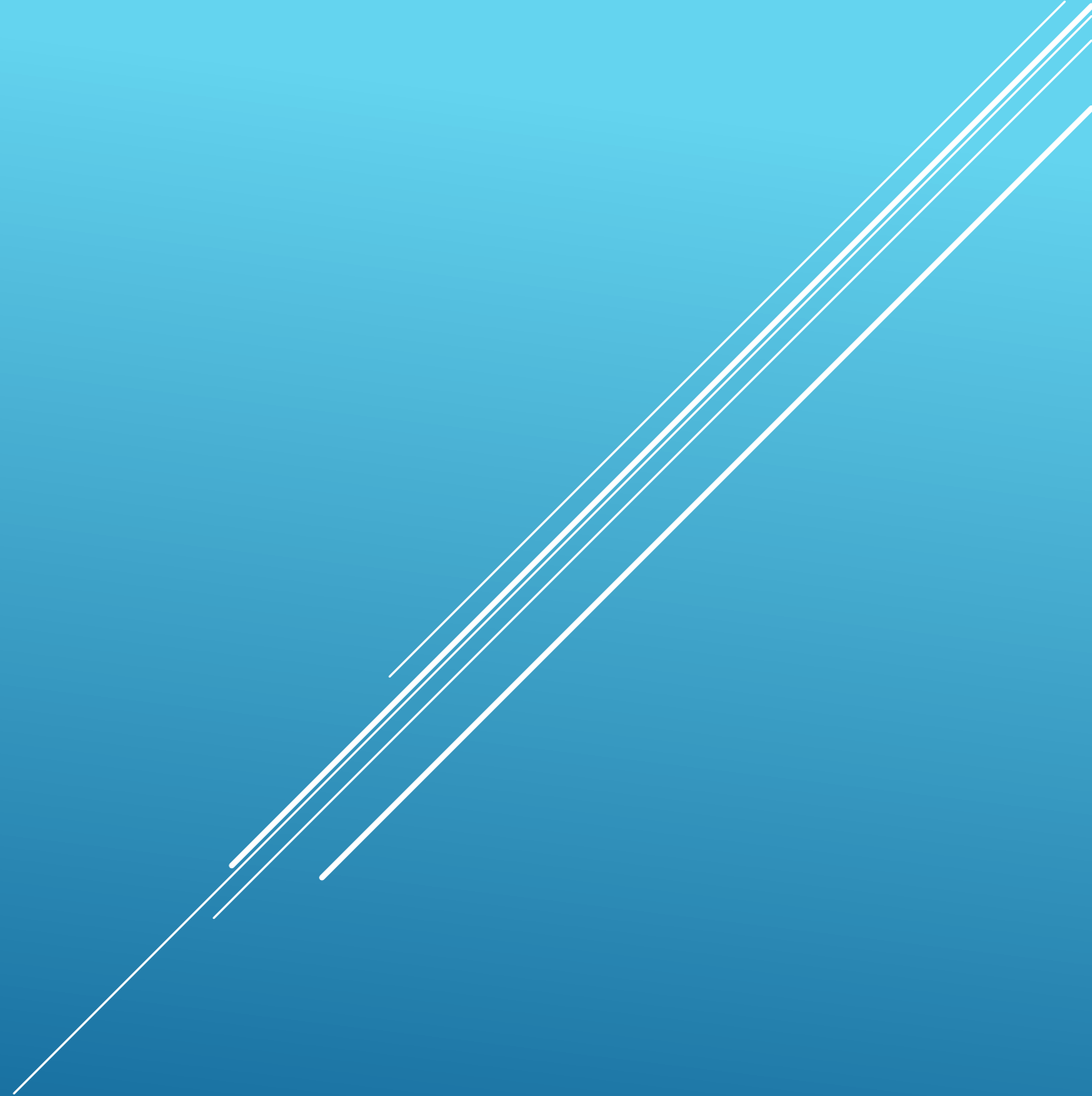

- ▶ EM vlnenie
- ▶ Zdrojom každé teleso
- ▶ Vzniká tepelným pohybom atómov a molekúl
- ▶ závisí od teploty, zloženia a štruktúry objektu

Farba	Teplotný interval [°C]
náznak červenej	500 – 550
tmavo červená	650 – 750
jasno červená s nádychom oranžovej	850 – 950
červená s nádychom do žltá	1 050 – 1 150
vznikajúca biela	1 250 – 1 350
biela	1 450 – 1 550

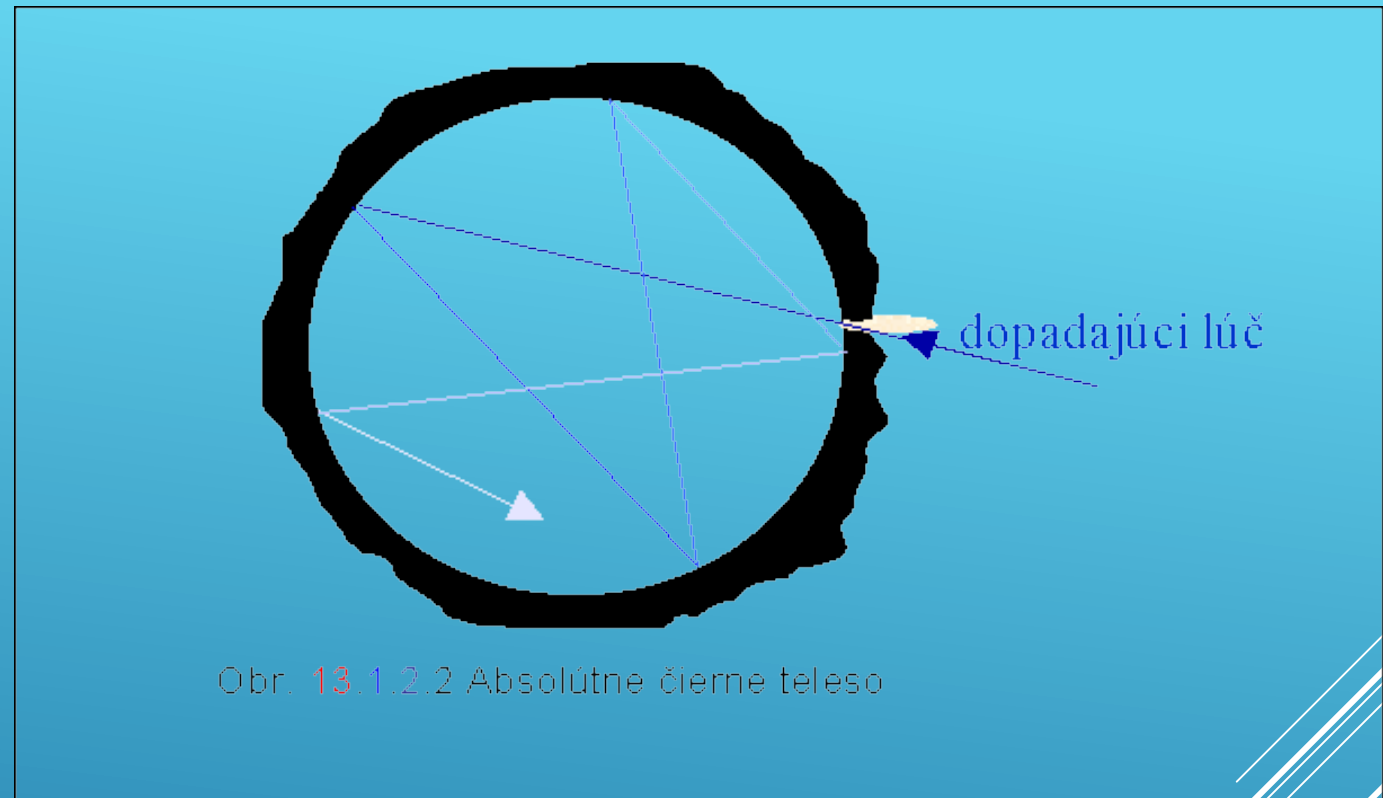
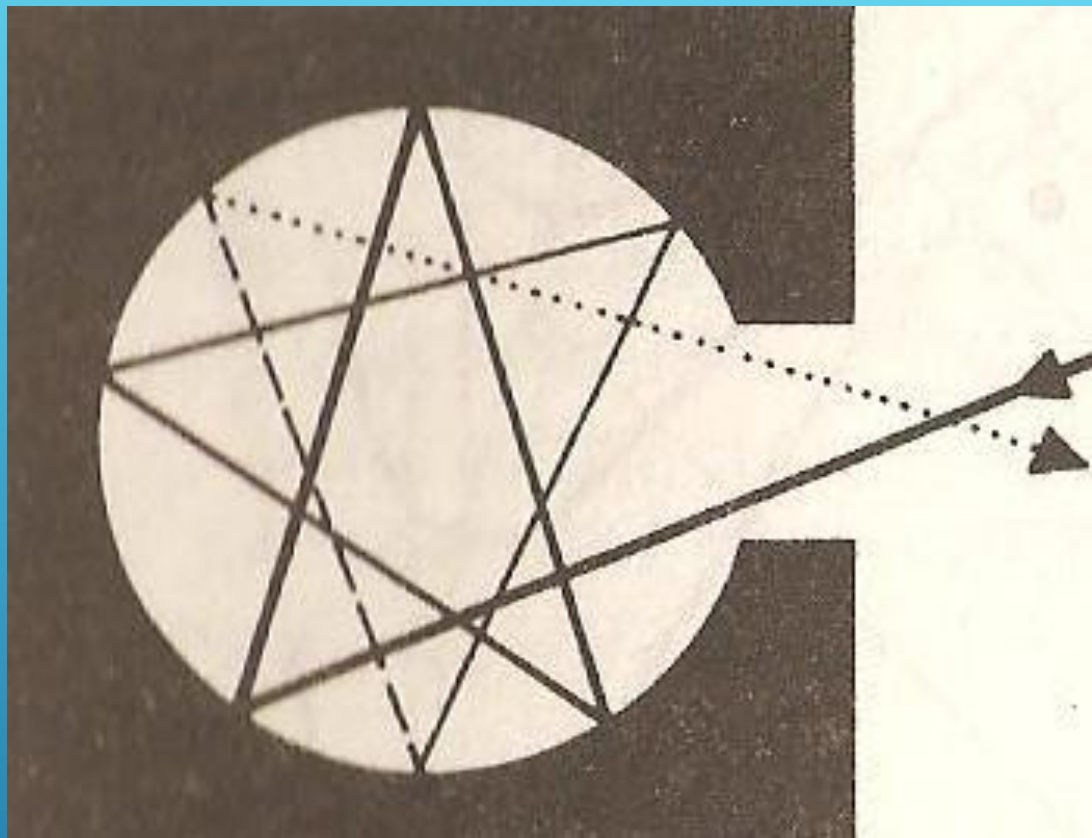

ABSOLÚTNE ČIERNE TELESO



MAX PLANCK

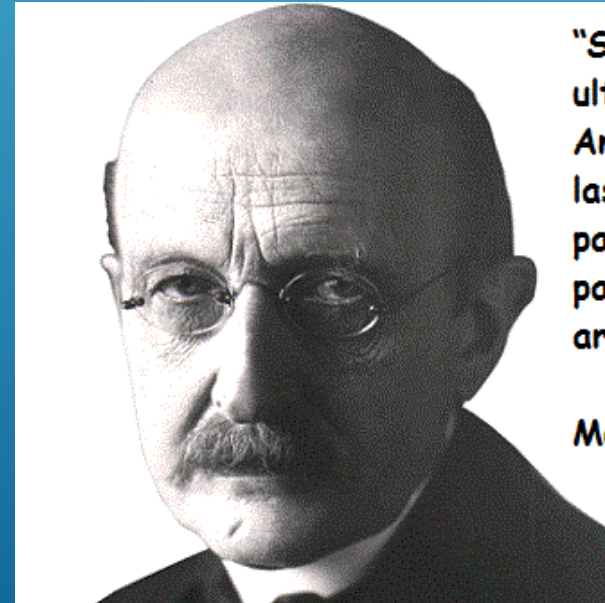
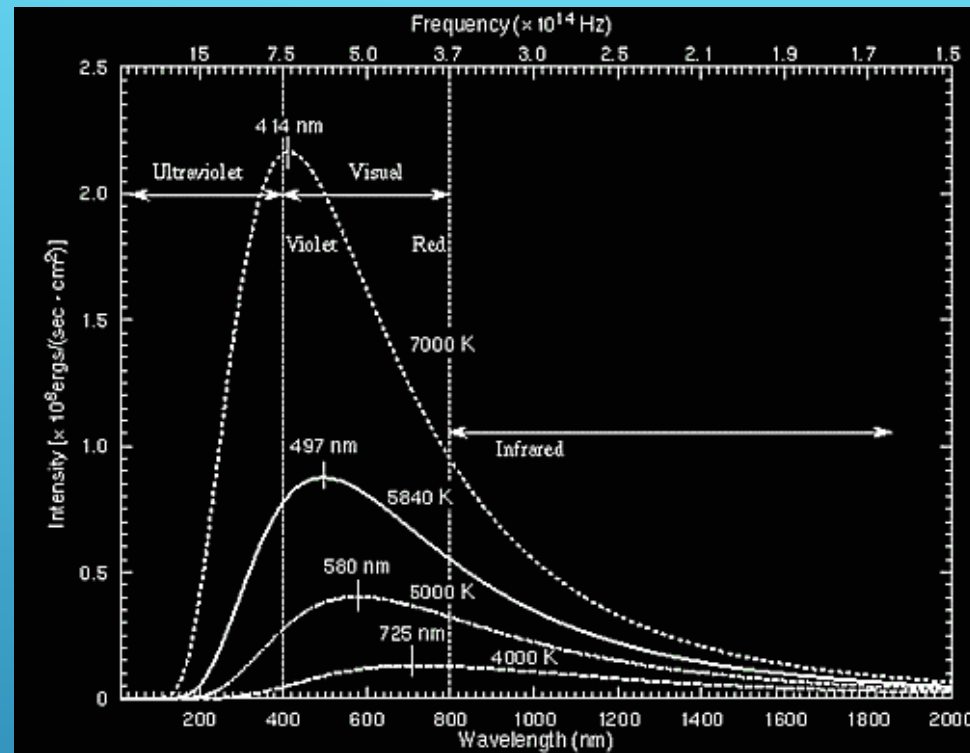

"Science cannot solve the ultimate mystery of nature. And that is because, in the last analysis, we ourselves are part of nature and therefore part of the mystery that we are trying to solve."

Max Planck

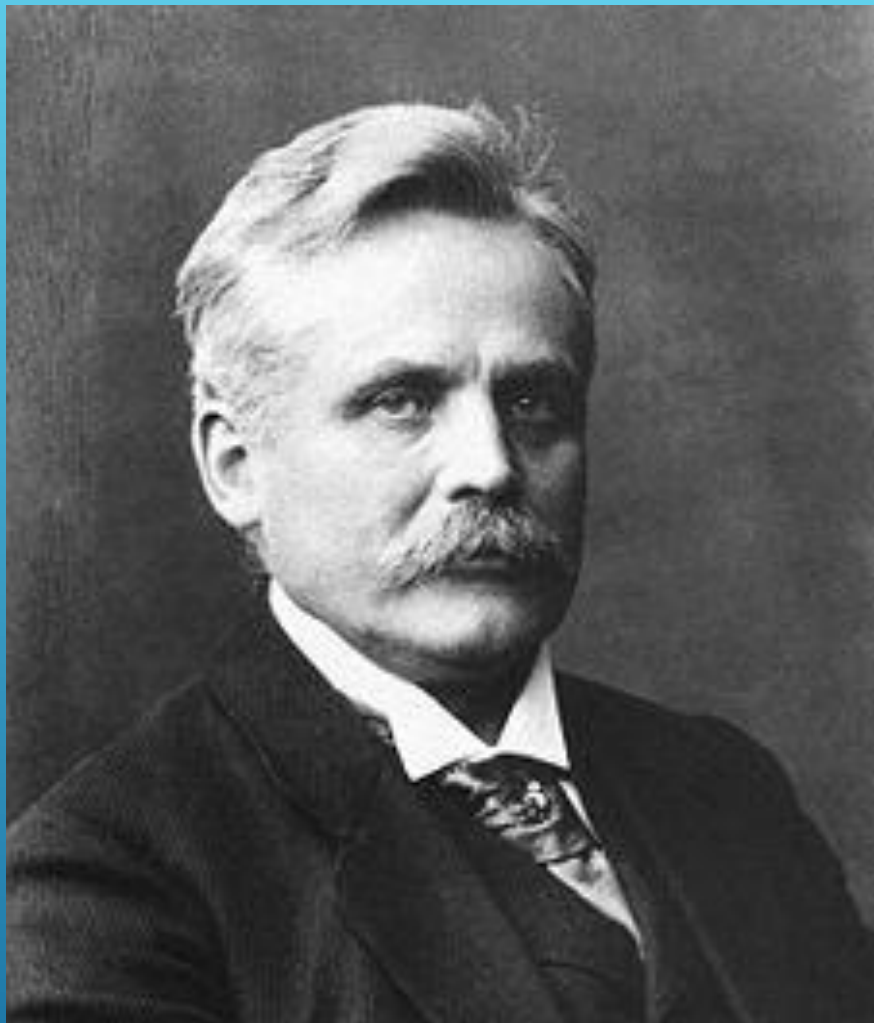

WILHELM WIEN

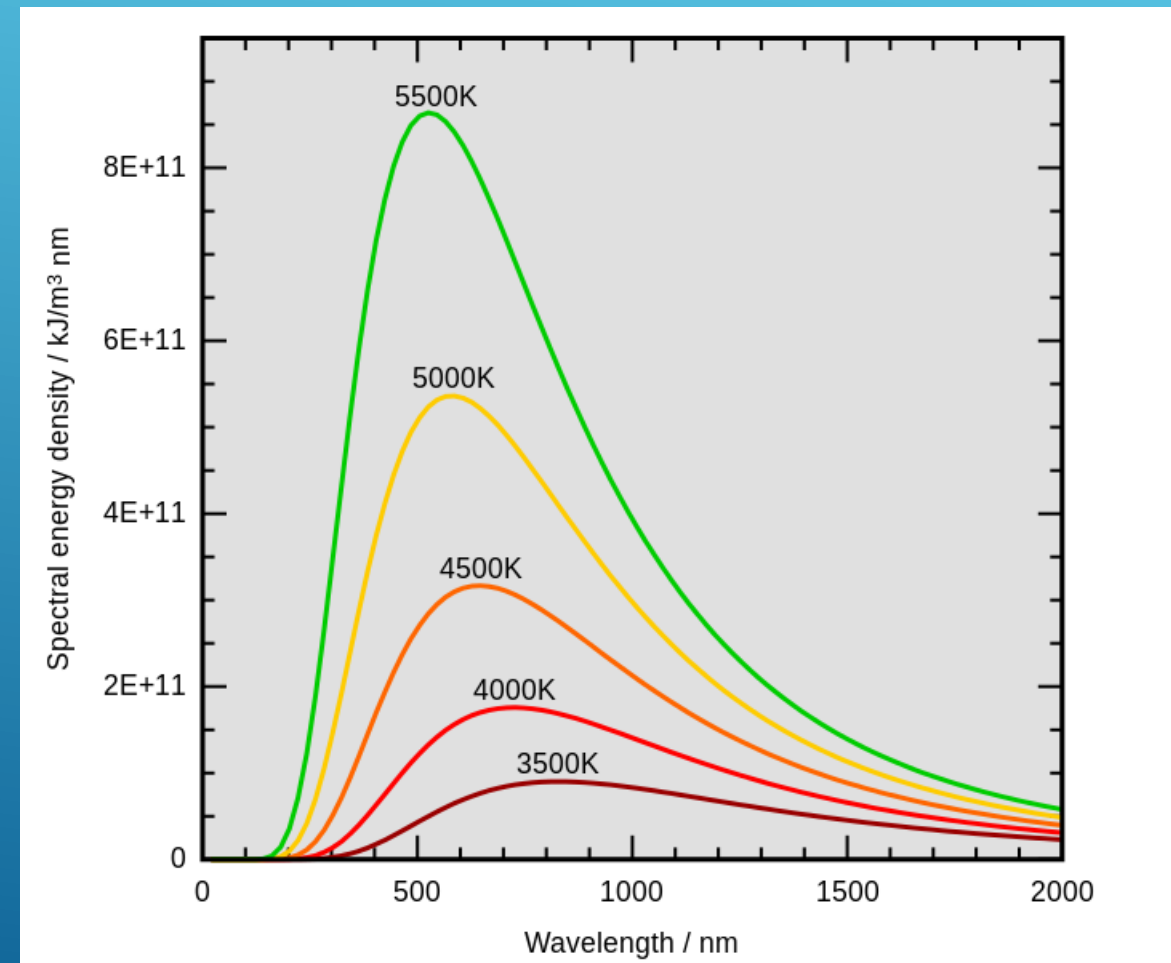

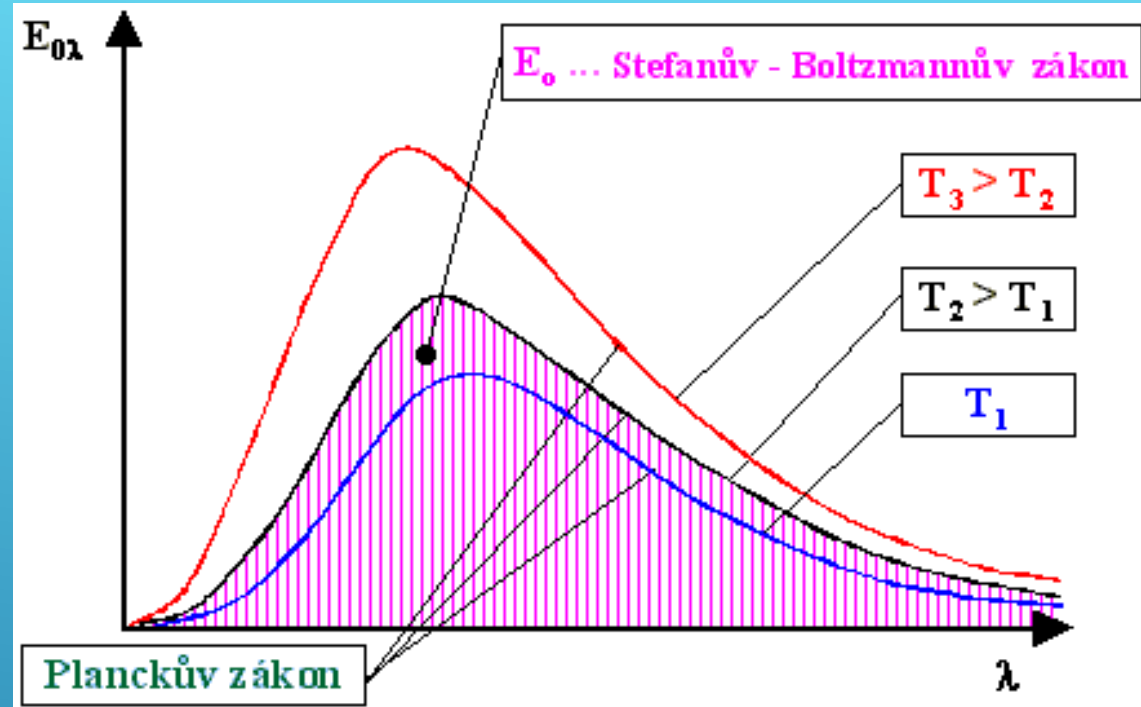

LUDWIG BOLTZMANN
JOSEF STEFAN

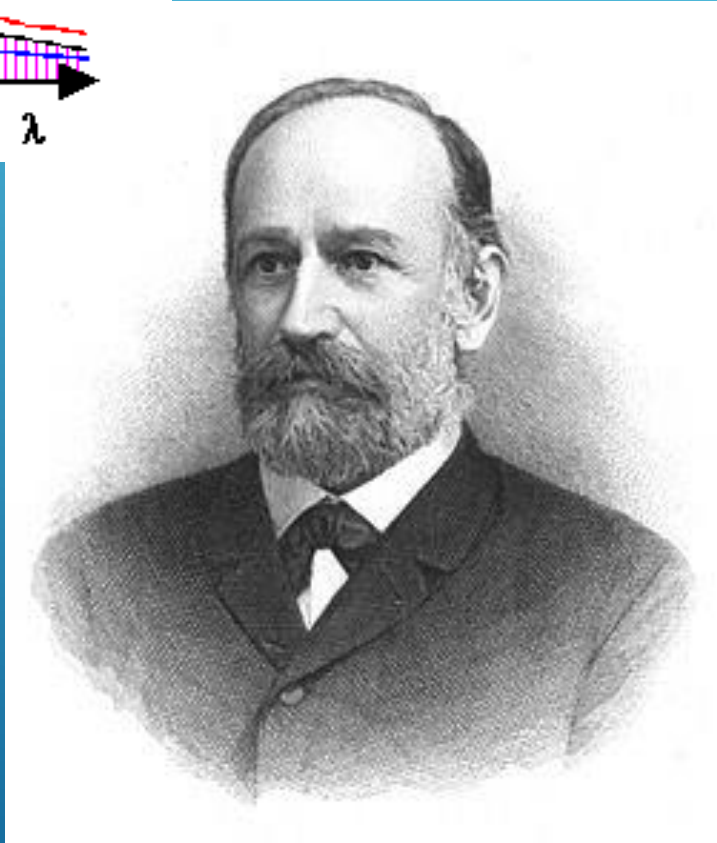

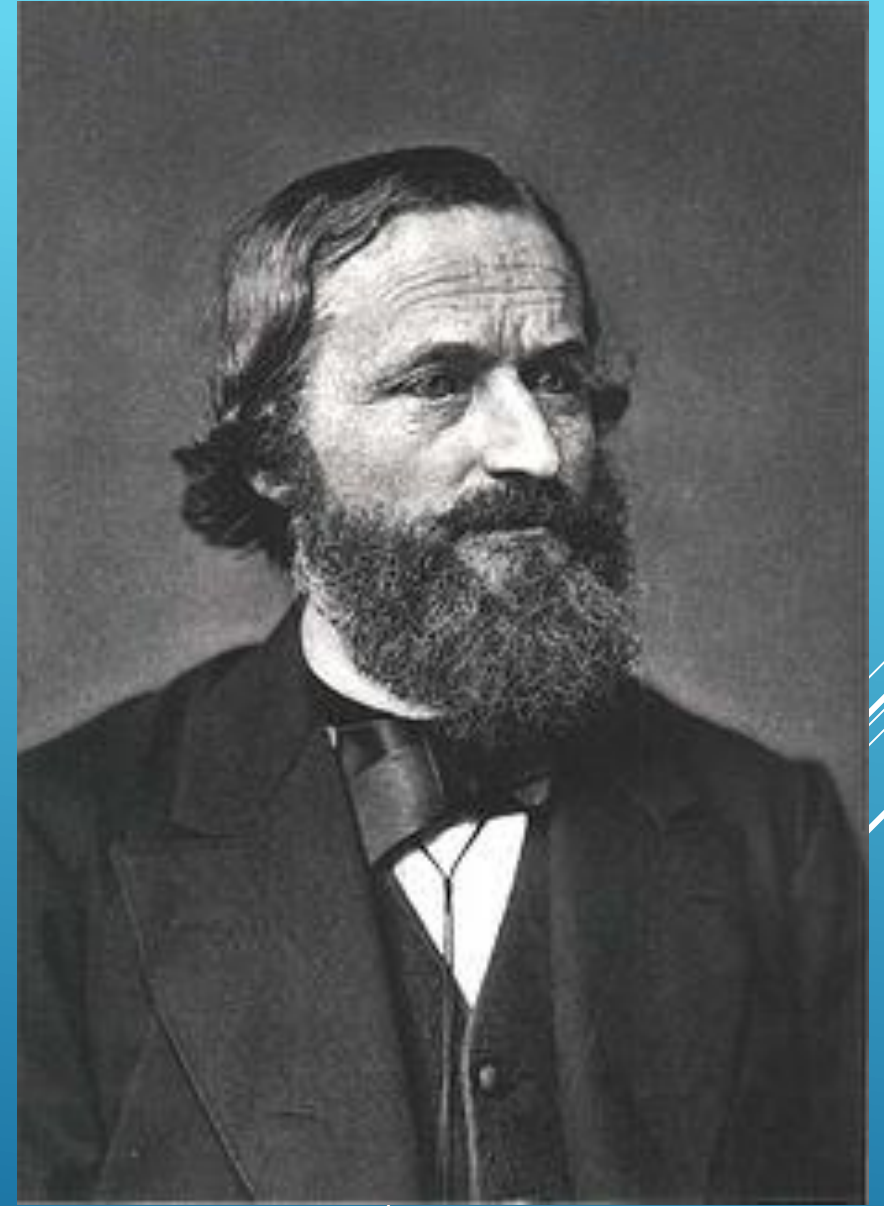
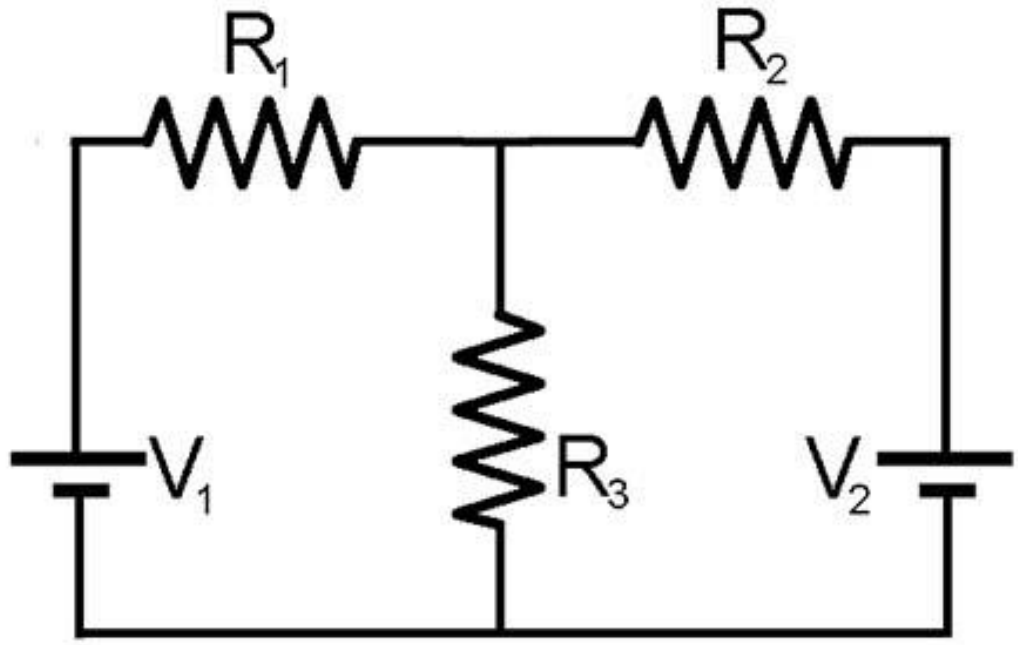

GUSTAV ROBERT KIRCHHOFF

ĎAKUJEM ZA POZORNOST! 😊

